

MX010-IP2

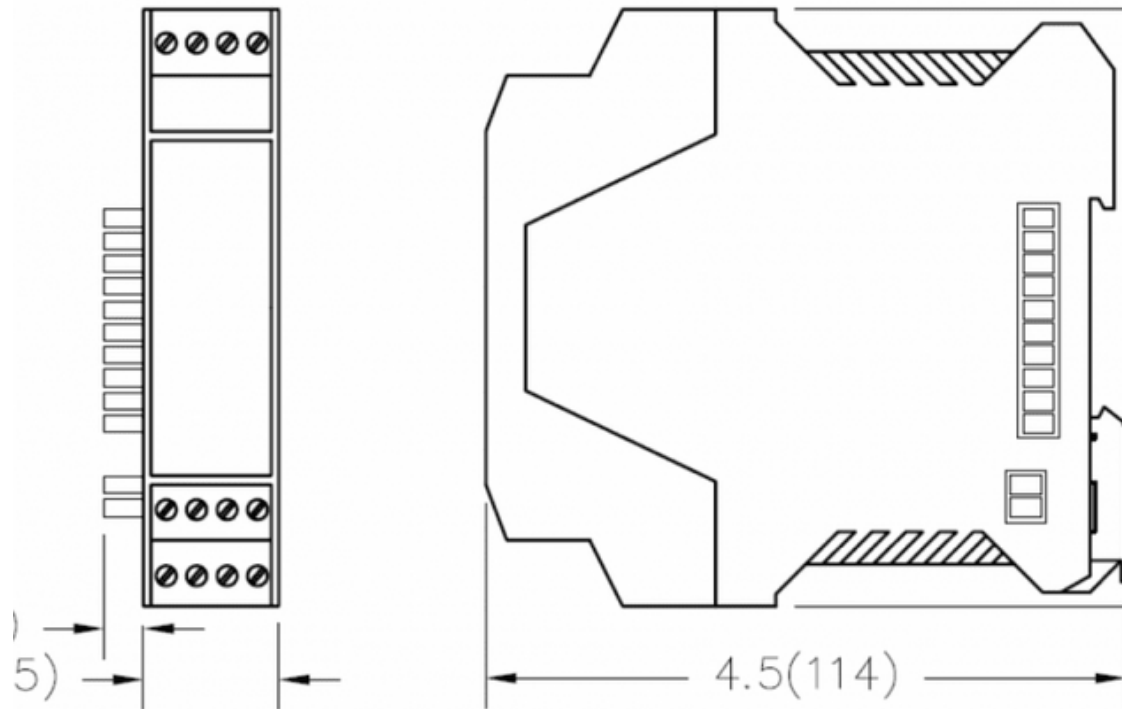

Feature	Description
I/O module type	0-10Vdc in
Channels	2
Accessories	Base units: MXB-MM2, MXB-SM15, MXB-SM40, MXB-SM80, MXBMN

About Ultra Energy

Organizations working with nuclear and industrial technologies must deliver reliable production at the same time as safeguarding people, the environment and infrastructure. We develop and manufacture measurement and control solutions that give our customers complete, long-term control over systems operating in harsh environments, helping them operate safely and increasing the value derived from their investments over their total lifespan.

Part of Ultra Group, a global electronics company, Ultra Energy has worked with nuclear and industrial customers for over 60 years. We support customers across the world from facilities located in the US and UK. Our solutions are embedded in strategic national infrastructure and our people are active partners in customer programs that are focused on delivering advanced future nuclear and industrial capabilities.

United States of America

707 Jeffrey Way
Round Rock
Texas 78665-2408
USA

Tel: +1 512-434-2800

United Kingdom

Innovation House
Lancaster Road
Ferndown Industrial Estate
Wimborne
Dorset BH21 7SQ
UK

Tel: +44 (0) 1202 850 450

For more information

Web: ultra.energy
Email: sales@ultra.energy